

Pz.Kpfw.IV Ausf. H Vomag

EARLY PROD. JUNE 1943

35302



GENERAL INSTRUCTION

- HIGHLY DETAILED PLASTIC MODEL KIT
- WORKABLE TRACKS INCLUDED
- PHOTO-ETCHED PARTS INCLUDED
- CLEAR PLASTIC PARTS INCLUDED
- ALL HATCHES CAN BE ASSEMBLED IN OPEN OR CLOSED POSITION
- METAL SURFACES AND WELD LINES ACCURATELY REPRESENTED IN THE MODEL
- DECAL SHEET FOR 5 OPTIONS

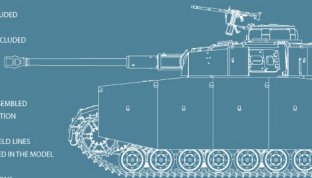

SCALE
1:35

MiniArt

PAINTING GUIDE

1 Undefined Unit. Before Operation Citadel. Summer 1943

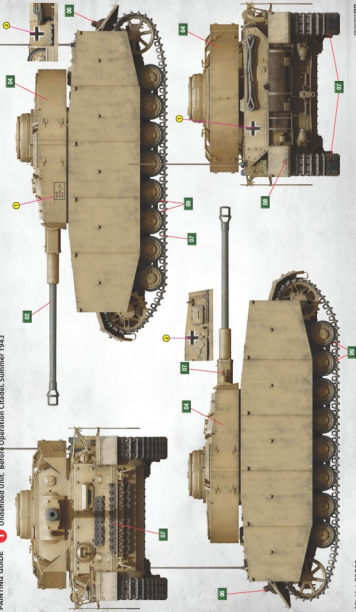

ATTENTION
Ne pas utiliser de colle ou de peinture à proximité d'une femme enceinte et éviter le bébé de temps en temps.
Pour retirer les pièces hors du cadre, utiliser des ciseaux adaptés pour empêcher le plastique en excès d'être un danger au sein d'un bébé.
Veuillez lire le cadre couleur pour la signification des symboles.
Après l'assemblage, ne pas laisser des pièces inutilisées.

TRAVAIL
Bitte verwenden keine Klebstoffe oder Farben in der Nähe einer schwangeren Frau und vermeiden Sie den Kontakt mit dem Baby über längere Zeiträume.
Zur Entfernung der Teile vom Werkstück sind geeignete Zangen zu verwenden. Überschüssiges Plastik sollte als Gefahr für Kleinkinder entfernt werden.
Bitte lesen Sie die farbige Rahmenbeschriftung für die Bedeutung der Symbole.
Nach dem Zusammenbau dürfen keine ungenutzten Teile übrig bleiben.

PRECAUTION
Do not use glue or paint in parts of a pregnant woman, and avoid the baby over long periods of time.
Details should be removed from the plastic using appropriate tools. Excess plastic is a potential hazard to children and should be removed.
Please read the color-coded frame for the meaning of symbols.
Do not leave any spare parts, especially unutilized details.
After assembly, do not leave unutilized parts.

ZUR BEACHTUNG!
Nicht bei einer schwangeren Frau verwenden und dem Baby von Zeit zu Zeit aus der Hand nehmen.
Zum Abschneiden der Teile vom Werkstück sind geeignete Zangen zu verwenden. Überschüssiges Plastik sollte als Gefahr für Kleinkinder entfernt werden.
Bitte lesen Sie die farbige Rahmenbeschriftung für die Bedeutung der Symbole.
Nach dem Zusammenbau dürfen keine ungenutzten Teile übrig bleiben.

ATTENZIONE
Non usare colla o vernici vicino a una donna incinta e evitare il bambino di tanto in tanto per lunghi periodi di tempo.
Quando si staccano parti del pezzo, usare forbici da modellismo o strumenti di plastica in acciaio per un taglio a caldo o una lima. Rimuovere il plastica in eccesso come un pericolo per i bambini.
Dopo l'assemblaggio possono rimanere parti inutilizzate.

CAUTION
When you use glue or paint, do not use near your future fetus, and use well-ventilated room. When you take parts off from the runner frame, use modelling scissors or callips.
See the bottom of the options for the meaning of symbols.
Extra details can remain after assembling of the kit.

PARTS

A1 x4

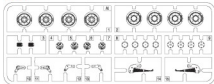

Ba x2

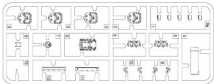

Eb

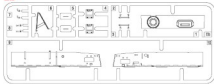

Ea

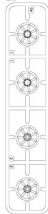

Bf x2



Kc (Clear parts)



Decal

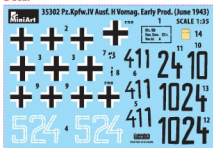

PEb parts

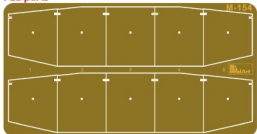

PEa parts

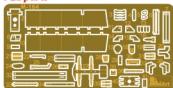



SAFETY
 PLEASE READ
 THE INSTRUCTIONS
 CAREFULLY
 BEFORE USING
 THE TOOL
 TO AVOID ACCIDENTS
 AND INJURY



DO NOT USE
 FOR PURPOSES
 NOT INTENDED
 FOR
 USE IN
 EXPLOSIVE
 ATMOSPHERES



DO NOT
 TOUCH THE
 HOT SURFACE
 OF THE
 TOOL
 DURING
 OPERATION
 TO AVOID
 BURNS



DO NOT
 OPERATE
 THE TOOL
 WITHOUT
 THE
 PROTECTIVE
 HOOD
 IN PLACE
 TO AVOID
 INJURY



DO NOT
 OPERATE
 THE TOOL
 WITHOUT
 THE
 PROTECTIVE
 HOOD
 IN PLACE
 TO AVOID
 INJURY



DO NOT
 OPERATE
 THE TOOL
 WITHOUT
 THE
 PROTECTIVE
 HOOD
 IN PLACE
 TO AVOID
 INJURY



DO NOT
 OPERATE
 THE TOOL
 WITHOUT
 THE
 PROTECTIVE
 HOOD
 IN PLACE
 TO AVOID
 INJURY

PARTS

Ed

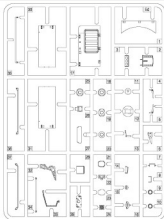

Ke

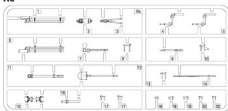

Jd

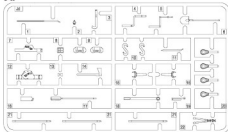

Be x2

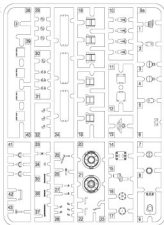

Lg

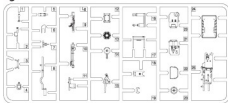

Tracks x22



Af x4

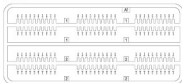

Ag



Ld

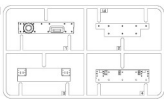

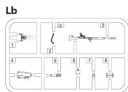
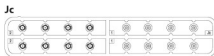
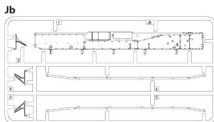
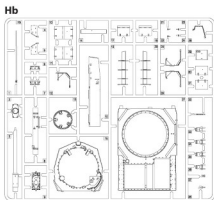
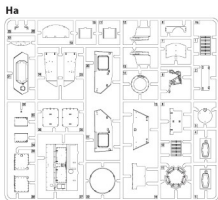
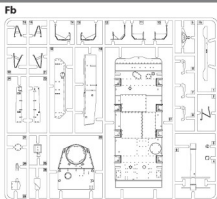
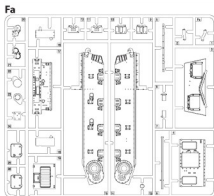

1

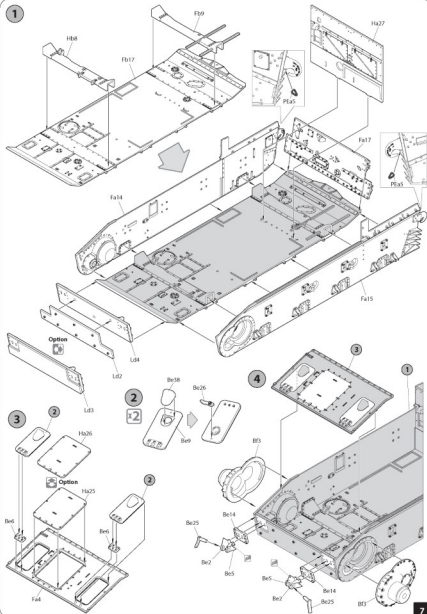

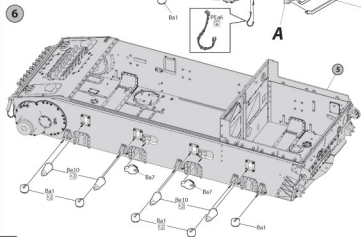
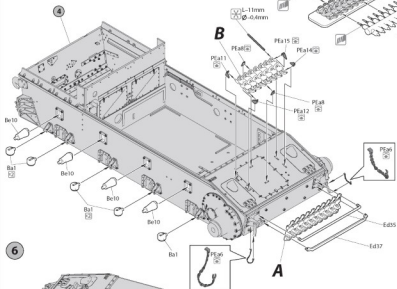
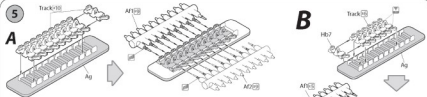

7

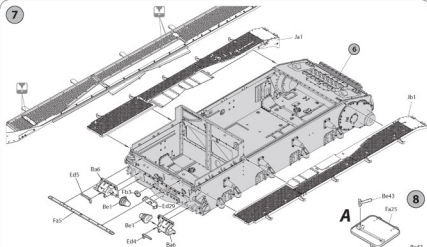

8



9

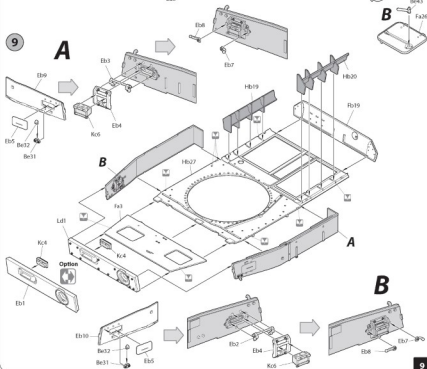

9

10

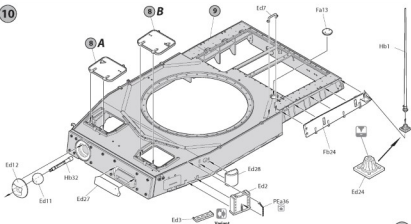

11

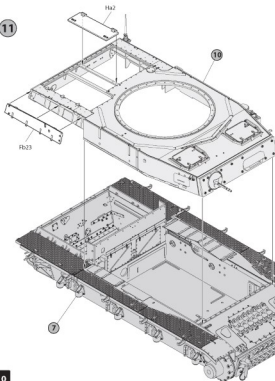

12

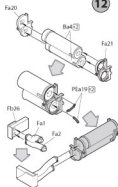

13

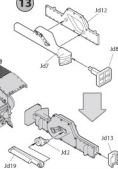

10

14

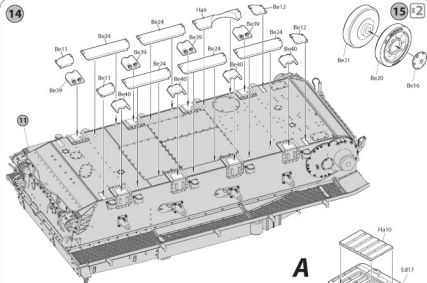

15

x2

16

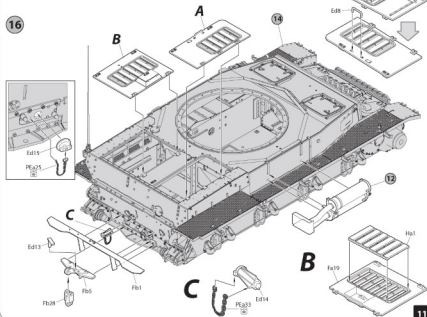

11

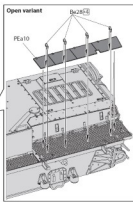
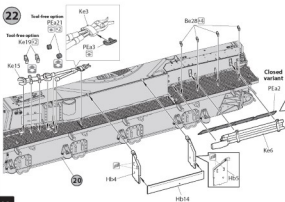
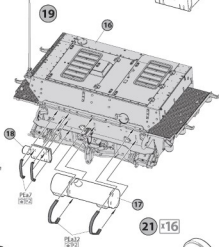
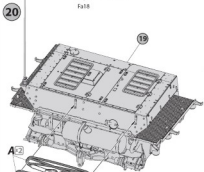
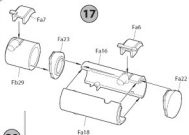

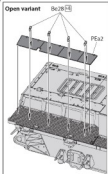

23

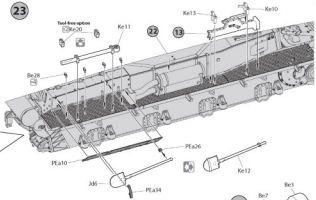

24

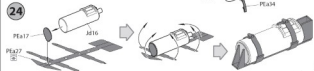

25



26

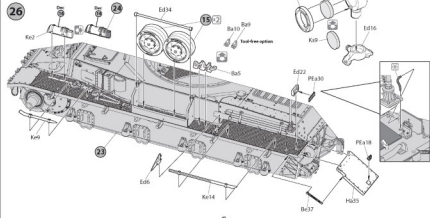

27

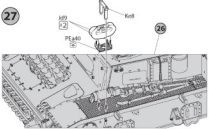

28

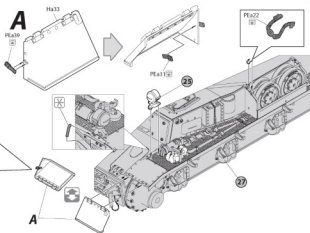
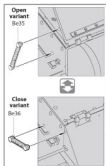

29

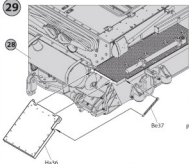

30

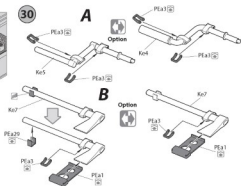

31 x2



32 x2

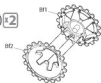

29

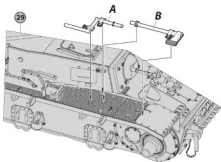

37 x2

Repeat on the reverse side

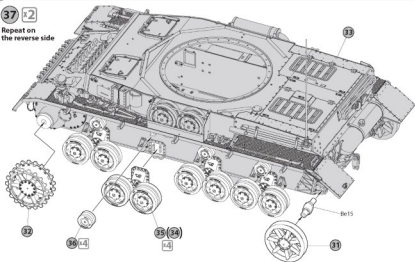

38 x2

Each track links contains 101 tracks

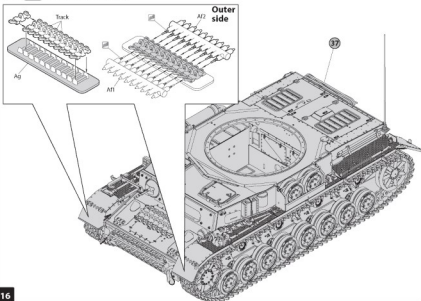

39

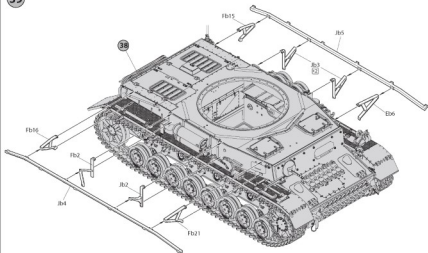

40

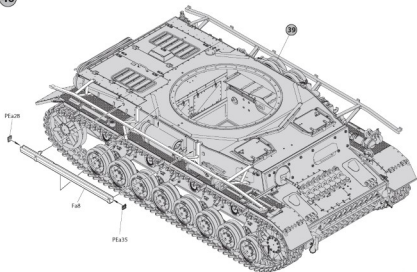

41

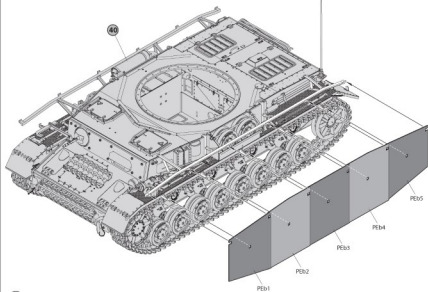

42

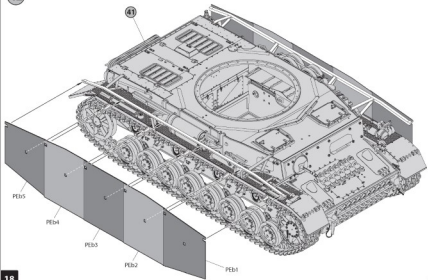

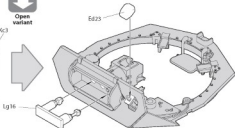
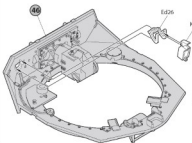
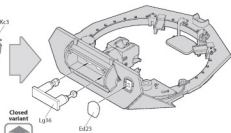
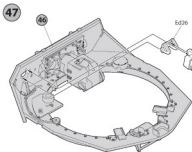
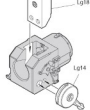
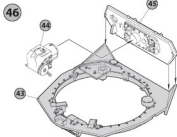
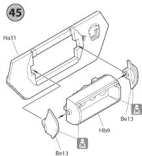
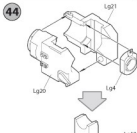
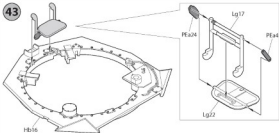

48

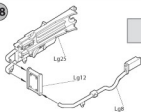

49

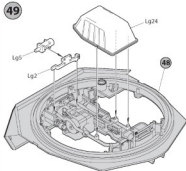

50

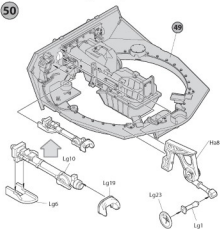

51

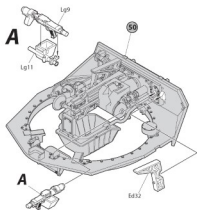

52

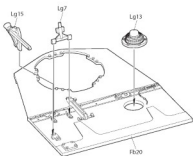

53

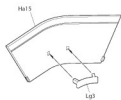

54

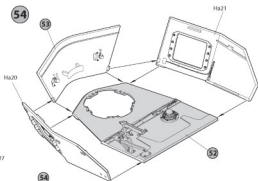

55

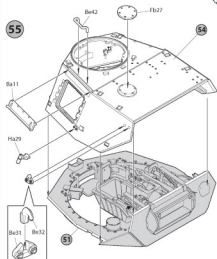

56

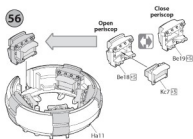

57

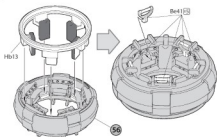

58

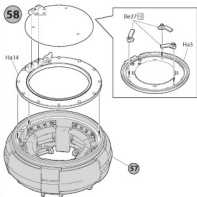
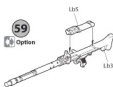
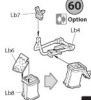
59
Option60
Option

61

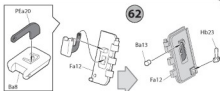
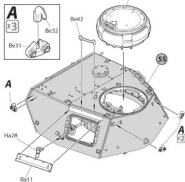

62

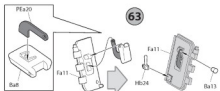

63

66

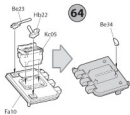
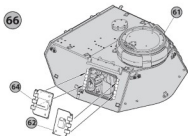

64

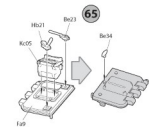

65

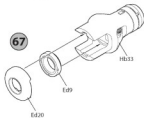

67

68

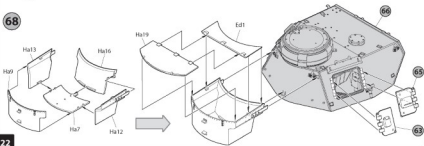

69

70

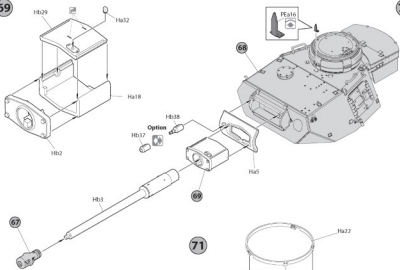

72

71

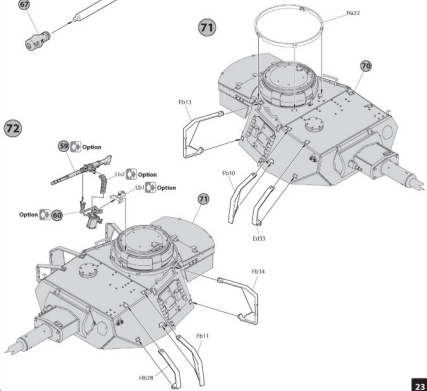

73

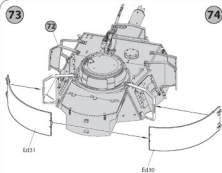

74

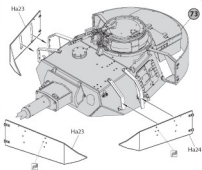

75

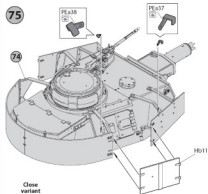

76

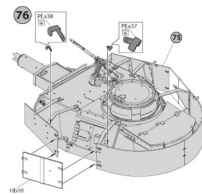

Close variant



Open variant

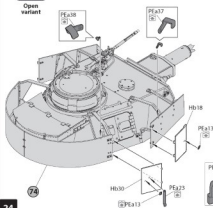

Close variant



Open variant

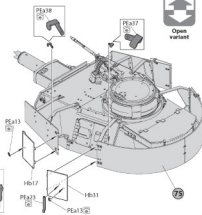

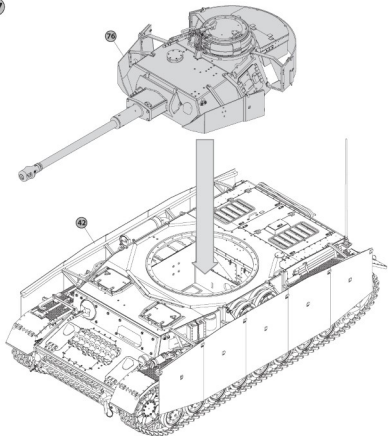

COLOR CHART

Nº	Color	Vallejo	Mr. Color	AK RC	Mission Models	AMMO MIG	Tamiya	Color name
01		71.001	C-062	RC-004	MMP-001	A.MIG-0050	XF-02	White
02		71.056	C-040	RC-057	MMP-014	A.MIG-0008	XF-63	Dunkelgrau
03		71.007	C-038	RC-023	MMP-025	A.MIG-0081	XF-62	Olive Green
04		71.025	C-039	RC-062	MMP-011	A.MIG-0010	XF-60	Dunkelgelb
05		71.072	C-028	AK-476	MMM-002	A.MIG-0191	XF-56	Steel
06		71.069	C-131	AK-709	MMW-001	A.MIG-0041	XF-10	Rust
07		71.073	C-078	RC-015	MMM-001	A.MIG-0045	XF-84	Gun Metal
08		71.003	C-003	RC-006	MMP-003	A.MIG-0049	XF-07	Red
09		71.251	C-137	RC-022	MMP-040	A.MIG-0033	XF-85	Tire Black

PAINTING GUIDE

3 Pz.Regt. 35, 4.Pz.Div. Ukraine, Kovel District. Spring 1944

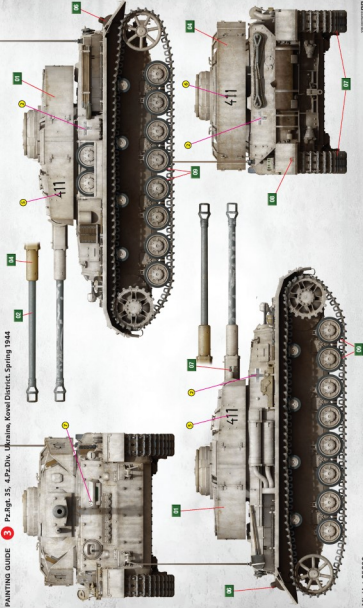

PAINTING GUIDE 4 Undefined Unit, Ukraine, Kovel District, Spring 1944

